

CHARGE AIR COOLERS

CACRAM001CM



70MM 70MM

CACRAM001CM
655MM X 250MM
110MM
ALUM

RAM 2500 6.7L '13-



COMPLETE RADIATORS

MER100PACA



35MM 15MM

MER100PACA
690MM X 440MM
25MM
AL/PL

MERCEDES SPRINTER - W607, W910, 2.1L '20-



CONDENSERS

CNIS49



NISSAN X-TRAIL T33 2.5L '22-



CLEX10



LEXUS RX450H/HL GYL20/25/26 '15-
 3.5LTR ELECTRIC / PETROL



TRANSMISSION OIL COOLERS

CKIA51



KIA NIRO SG2 1.6L '23- (G4LL ENGINE)
 HYUNDAI SX2 1.6L '23- (G4LL ENGINE)



TC4544

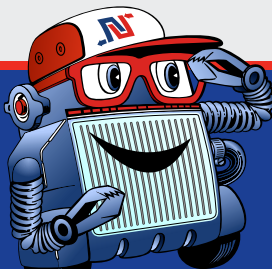

TRANS COOLER - FIN & PLATE
 241 X 280 X 19MM / BTU RATING
 20,000 - 30 PLATE

Click into Natrad!

natradtrade.com.au



Australian Owned & Operated

INDUSTRIAL RADIATORS

TOY015PACA



TOY015PACA
425MM X 445MM
90MM
AL/PL

30MM 275MM 30MM

TOYOTA FORKLIFT - AUTO 6FG 15/16



PER020PACM



PER020PACM
690MM X 680MM
55MM
AL/PL

50MM 55MM

PERKINS CATERPILLAR GENSET - DE150, DE200, DE220



MAC016ACM



MACK VOLVO SUPERLINER - LOW TEMP COOLER
FH - LOW TEMP COOLER



YAN001PACM

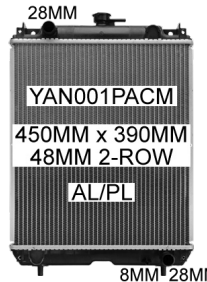

YAN001PACM
450MM x 390MM
48MM 2-ROW
AL/PL

28MM 8MM 28MM

YANMAR FORKLIFT KOMATSU PC40/45



KUB017PACM



KUB017PACM
550MM X 460MM
50MM
AL/PL

30MM 8MM 30MM

KUBOTA MINI EXCAVATOR YANMAR ENGINE





CORROSION INHIBITOR COOLANTS

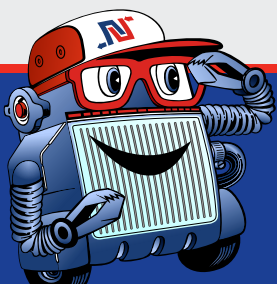

UP TO **40%**
MORE EFFECTIVE
HEAT TRANSFER
THAN ANTI-FREEZE

AVAILABLE SIZES:
5L, 20L, 205L, 1,000L



Click into Natrad!

natradtrade.com.au



Australian Owned & Operated

INDUSTRIAL CHARGE AIR COOLERS

CACBPMAC016CM

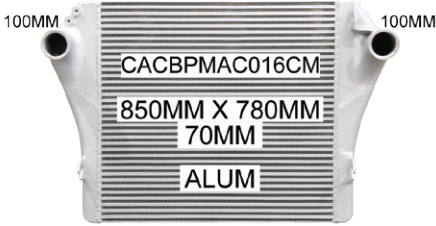

100MM 100MM

CACBPMAC016CM
850MM X 780MM
70MM
ALUM

MACK SUPERLINER / TITAN



CACBPTER001CM

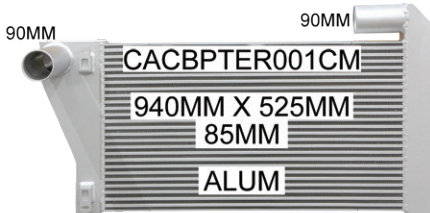

90MM 90MM

CACBPTER001CM
940MM X 525MM
85MM
ALUM

FRANNA TEREX CRANE - AT15 / AT20 / MAC25





ADRAD

CHARGE AIR HOSES

HEAVY DUTY

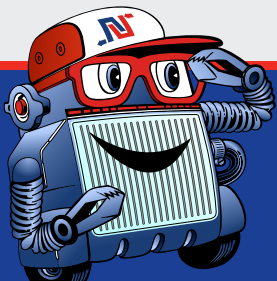
4 Ply Reinforcement Meets OE Quality Stainless Steel Rings



Click into Natrad!

natradtrade.com.au



Australian Owned & Operated

INDUSTRIAL STARTER MOTORS

STM500



KENWORTH
VOLVO
MACK

STARTER MOTOR - 38MT / 12V



STM501



CATERPILLAR
CUMMINS
DETROIT

STARTER MOTOR - 39MT / 24V



STM505



FREIGHTLINER
WESTERN STAR

STARTER MOTOR - 39MT / 12V



STM502



CUMMINS
VOLVO
NAVISTAR

STARTER MOTOR - 39MT / 24V



STM503



CATERPILLAR
CUMMINS
DETROIT

STARTER MOTOR - 39MT / 12V

Delco Remy®

Designed to start heavy duty & off-road vehicles in all conditions & environments

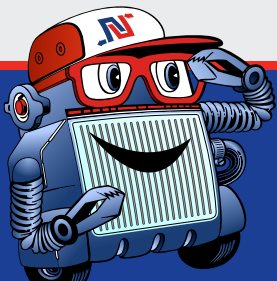

Click into Natrad!

natradtrade.com.au



Australian Owned & Operated

INDUSTRIAL ALTERNATORS

ALT504



CATERPILLAR
KOMATSU
TEREX

ALTERNATOR - 36SI / 24V / 105A



ALT500



VOLVO
MACK

ALTERNATOR - 22SI / 12V / 150A



ALT501



JCB
JOHN DEERE

ALTERNATOR - 24SI / 24V / 70A



Heavy Duty Alternators

Superior Performance for OE
& Aftermarket Applications

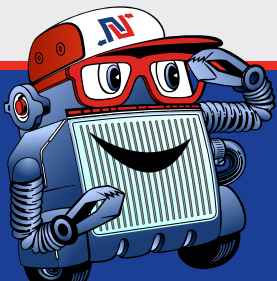

Click into Natrad!

natradtrade.com.au



Australian Owned
& Operated

STARTER MOTORS

STM158



KIA STONIC YB 1.0L '20-
RIO YB 1.0L '20-



Delphi Starter Motors



Over 100 years of OE experience, Delphi supplies to the worlds top automakers.

OE heritage and knowledge built into every aftermarket part.

ENGINE MOUNTS

A7663



mitsubishi TRITON ML / MN '06-09-



A7662



mitsubishi LANCER CJ / CF
OUTLANDER ZG / ZH





Leading Manufacturer of Engineered Rubber Solutions for Automotive, Defence & Industry

Australian rubber product manufacturer, Mackay Australia, is a major supplier of a diverse range of engineered rubber bonded products and bonded metal/rubber & composite products for the automotive, mining, rail, construction and industrial markets.

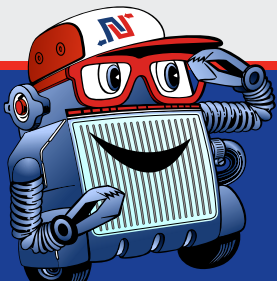

Click into Natrad!

natradtrade.com.au



Australian Owned & Operated